

17

open tunnel

ball: DM 084, C28, ...

spot:

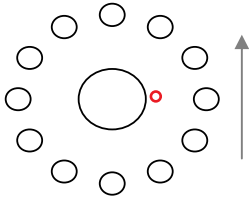

note: Legg ballen litt til seg, og spill inn mot midten. Banen drar litt venstre. Ballen skal gå direkt eller venstre om kopp.

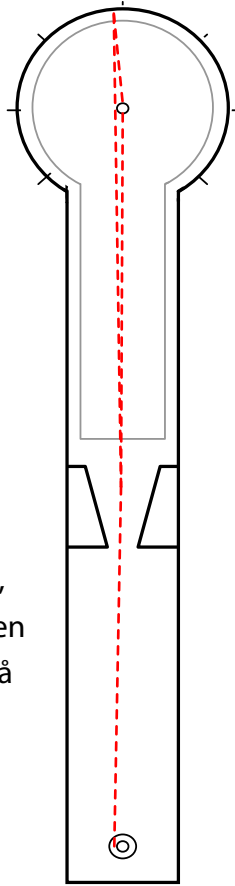

2

Stonehenge

ball: BoF SwM 99 Carl-Johan Ryner MR

spot:

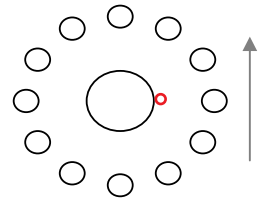

note: Spill i høyre vant og inn i stenen. Kan også spille i venstre stenen.

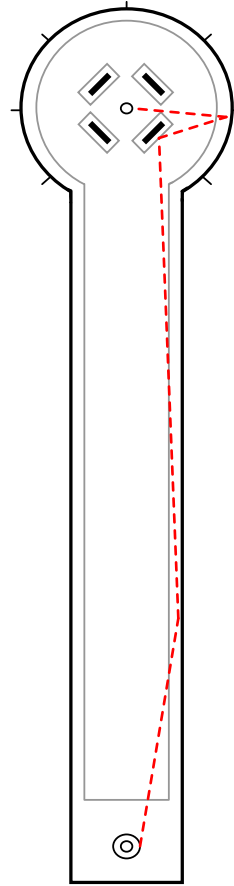

15

terrace

ball: BoF Verigate,

spot:

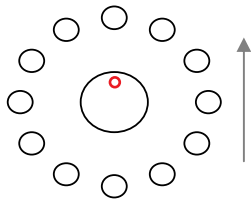

note: _____

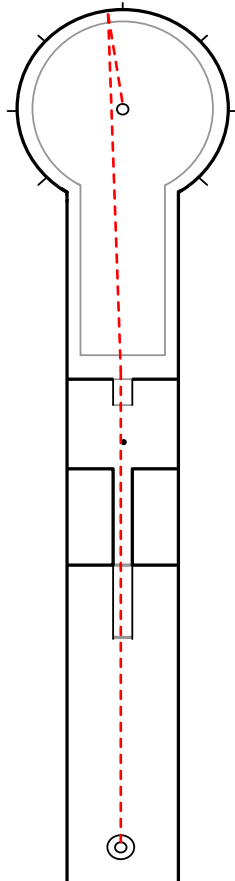

spot:

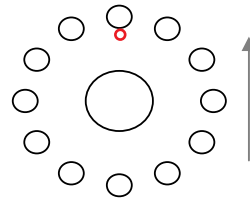

4

kiosk

ball: BoF Karin Wiklund, Mg Cl 5, Mg 5,

note: _____

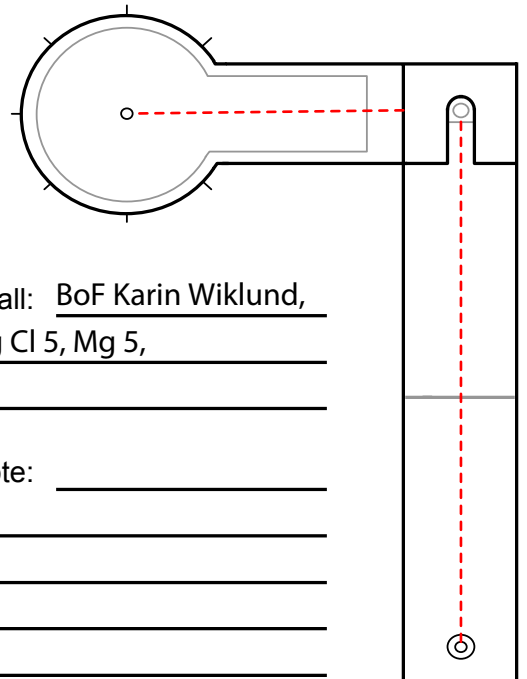

3 oyster

ball: BoF Miroslav Stoparic

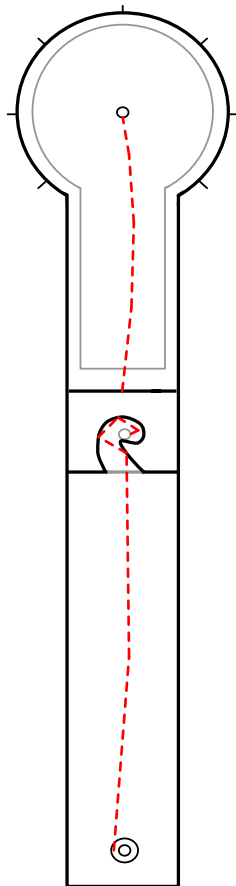
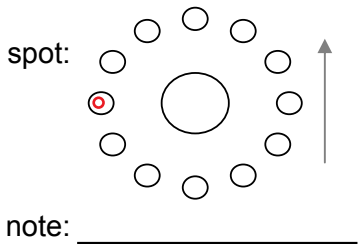

16 tube corner

ball: BoF Verigate,

note: ?

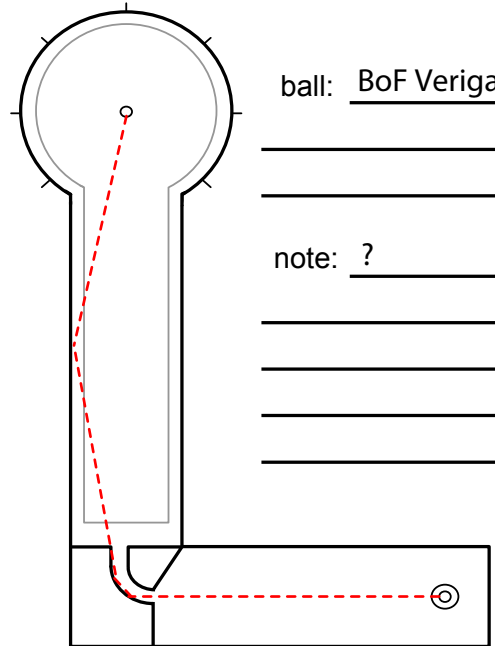
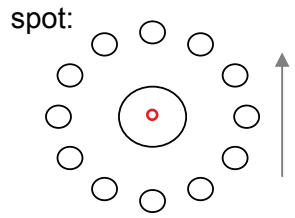

5 velodrome

ball: BoF Karin Wiklund MR,
Matt myk 20-30 cm.

note: Banen
drar høyre mot
greenen og hullet.

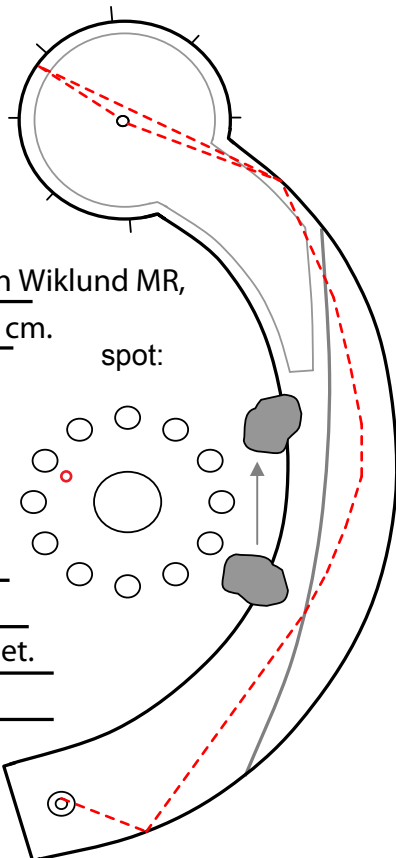

14 stones

ball: ?

spot: _____

note: ?

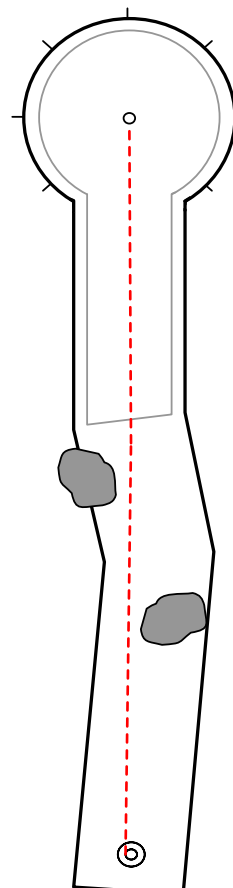

13

double velo

ball: DM 085

spot:

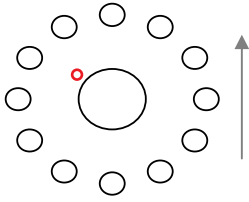

note: ?

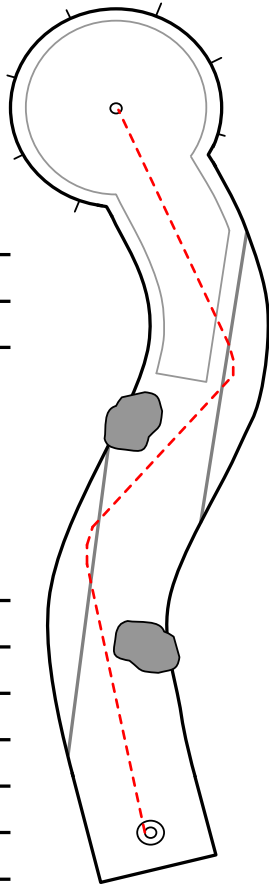

6

moat

ball: Ravensburg ???

spot:

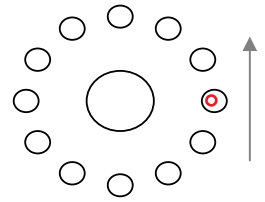

note: _____

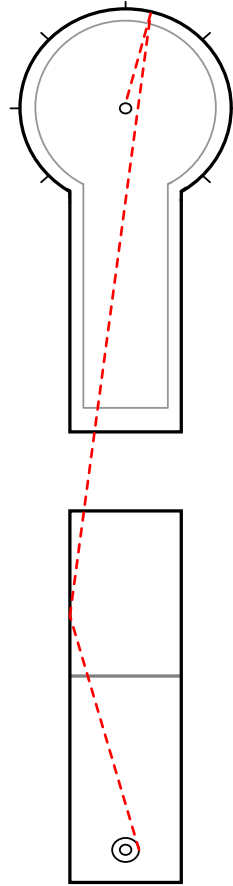

11

wall

ball: ???

spot:

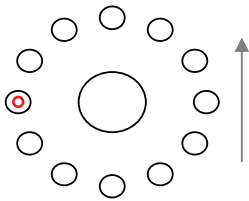

note: _____

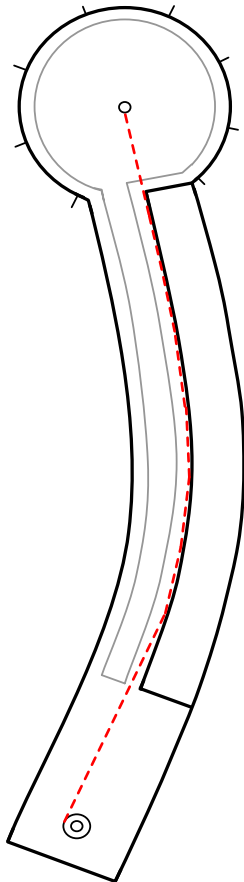

8

volcano

ball: BoF Peter/Sandra Nordin

spot:

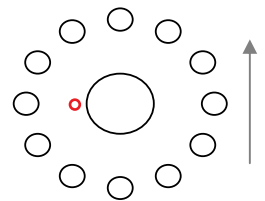

note: _____

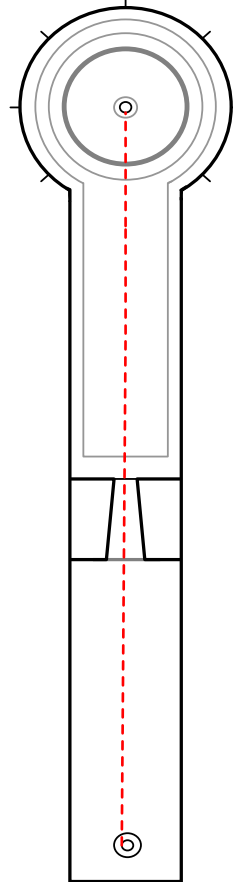

7

hammer cage

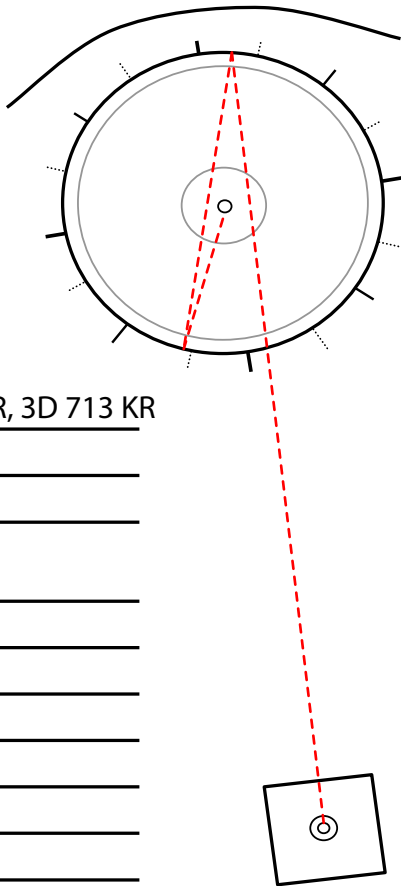

ball: 3D 613 MR, 3D 713 KR

note: _____

12

wide angle

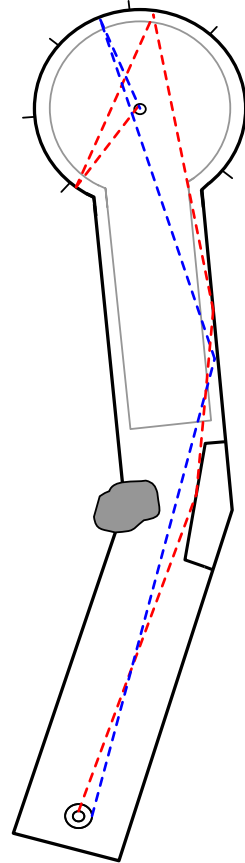

ball: Mg Maier Magnum 3

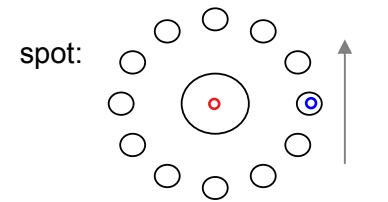

note: _____

ball: DM 086

9

open corner

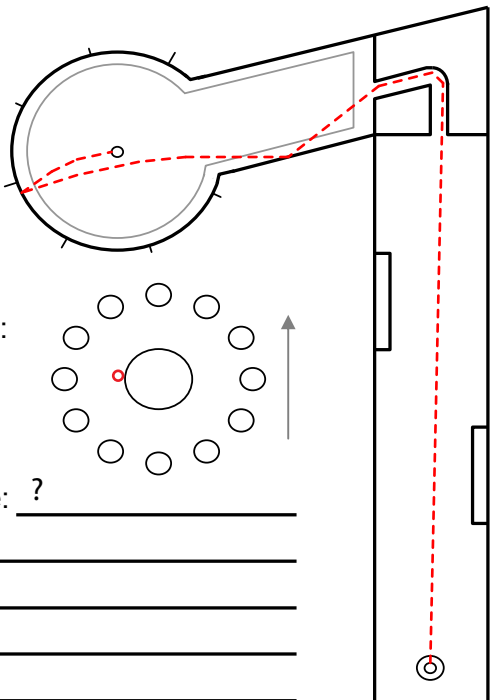

spot:

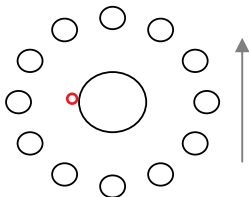

note: ?

10

triple hill

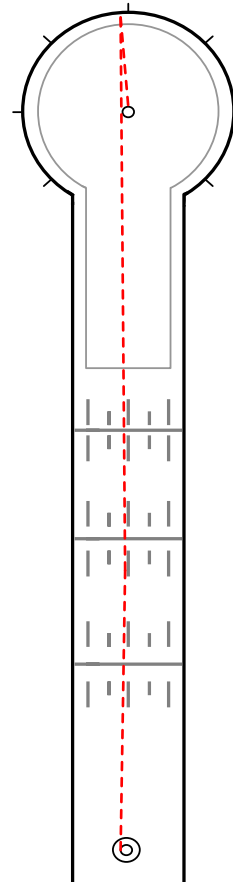

ball: ???

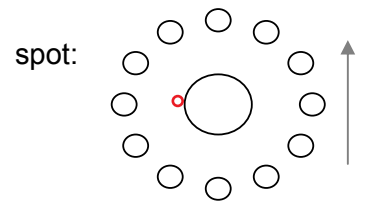

note: _____
