





# 17

## open tunnel

ball: DM 084, DM 085 (død)

Reisinger BA 10:0

spot:

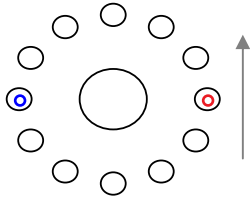

note: Første delen av banen drar høyre, mens den andre drar venstre. Ballen skal gå venstre om koppen, men den kan også gå i høyre om med tempo bare til kopp.

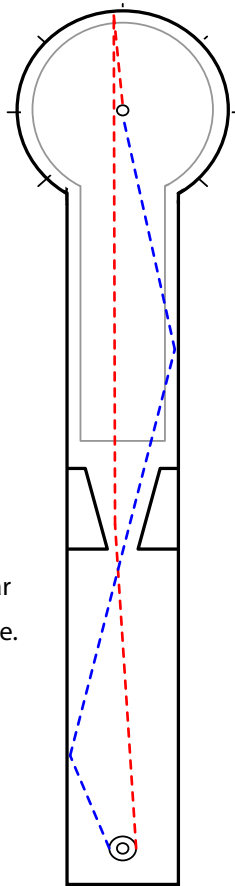

# 2

## Stonehenge

ball: BoF NLJM 2001 Erik Tiekstra KX,

BoF SEM 2004 Peter Nordin MX,

BoF PM 2005 Antonio Manuel MX,

M&G Edy Schibli KX

spot:

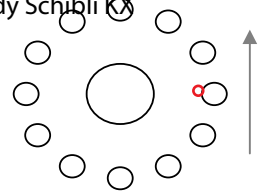

note: \_\_\_\_\_

\_\_\_\_\_

\_\_\_\_\_

\_\_\_\_\_

\_\_\_\_\_

\_\_\_\_\_

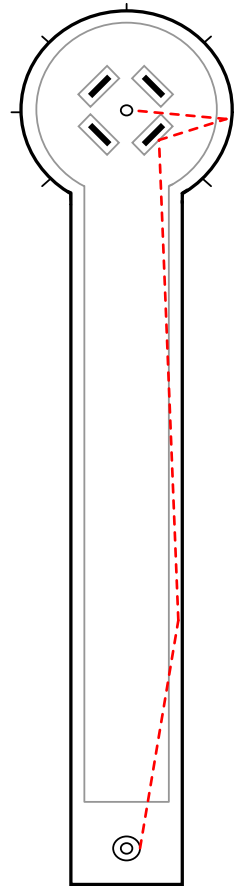

# 15

## terrace

ball: 3D Minigolfpics

BoF JEM1994 Anders Olsson,

BoF EC 2008 Uppsala/D

spot:

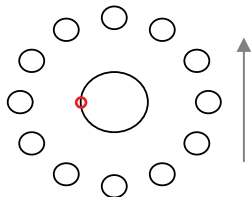

note: \_\_\_\_\_

\_\_\_\_\_

\_\_\_\_\_

\_\_\_\_\_

\_\_\_\_\_

\_\_\_\_\_

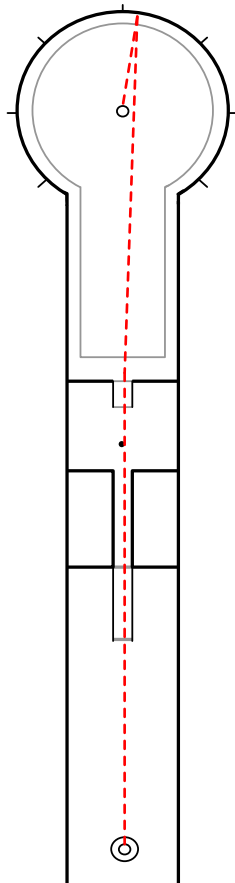

spot:

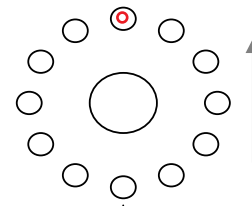

# 4

## kiosk

ball: BoF SM 2007 Remo Zaugg,

BoF DSchM 2006 Christian Roselieb,

BoF ÖMM 2005 WAT Florldsdorf/H,

BoF SwM 2003 Anders Olsson

note: \_\_\_\_\_

\_\_\_\_\_

\_\_\_\_\_

\_\_\_\_\_

\_\_\_\_\_

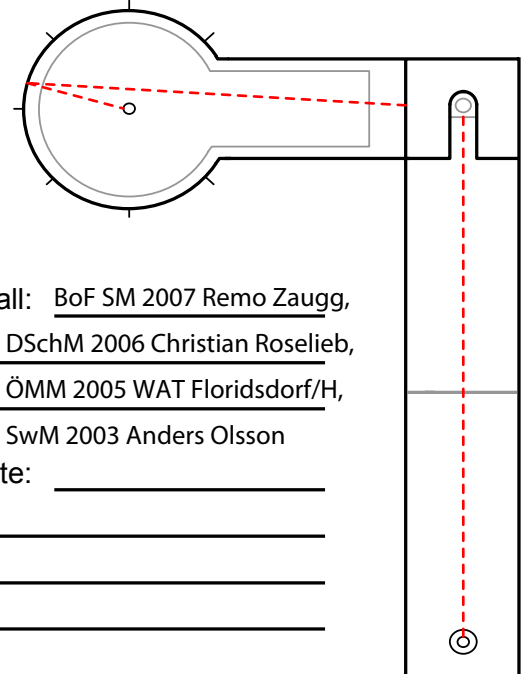

# 3 oyster

ball: BoF SMM 2001 Olten

---



---

spot:

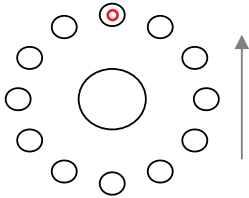

note:

---



---



---



---



---



---

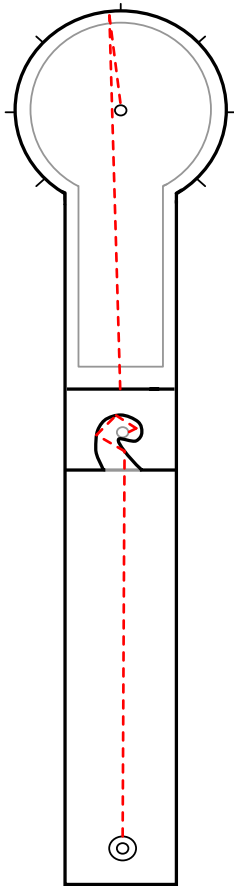

spot:

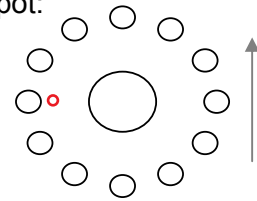

# 16 tube corner

ball: BoF BJM 2008 GSP Malonne KX,  
3D Uppsala 2008, Reisinger C4,  
BoF DMM 2006 Wanne Eickel/Sch. KX  
BoF DSM 2003 Peter Matern KX

note: \_\_\_\_\_

---



---



---



---

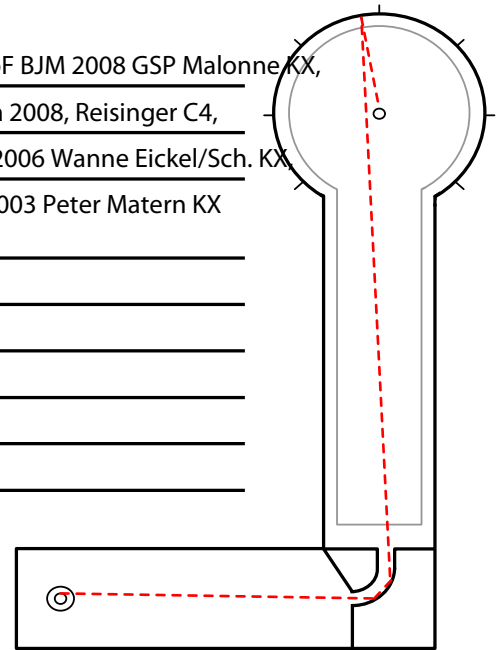

# 5 velo- drome

ball: DM Bel Ami,  
3D Västsvenska Bangolförbundet 2011 KX

---



---

spot:

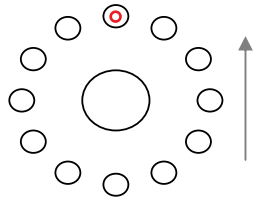

note:

---



---



---



---

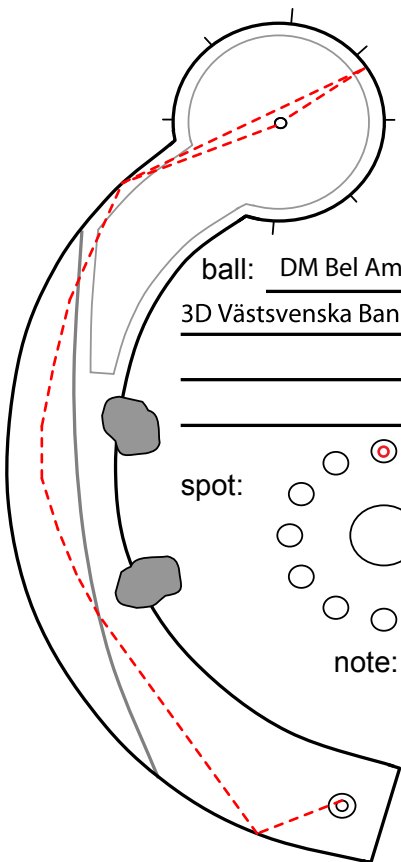

# 14 stones

ball: Reisinger Illertissen, 3D 426,  
Reisinger 20J. Osnabrück "Rot",  
Reisinger 20J. Osnabrück "Blau"

spot:

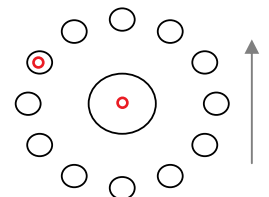

note: Ballen skal gå ca 10 cm  
venstre om kappen. Greenen  
drar ganske mye venstre.  
Viktig med bra tempo fra nakke,  
for da går mye inn mot kopp.

---



---



---



---

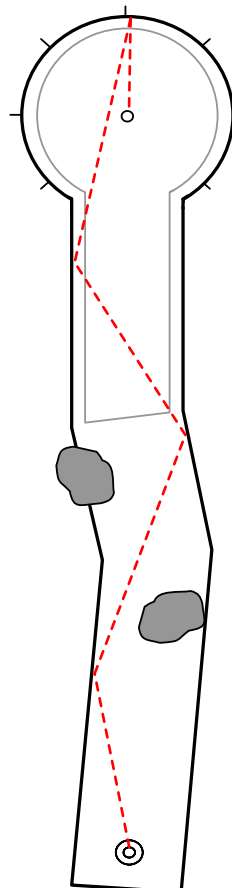

# 13 double velo

ball: DM 084, DM 085

spot:

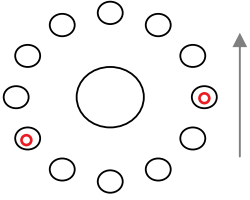

note: Ballen må ha bare tempo til kopp fra nakke. Kan gå i fra begge sider.

---

---

---

---

---

---

---

---

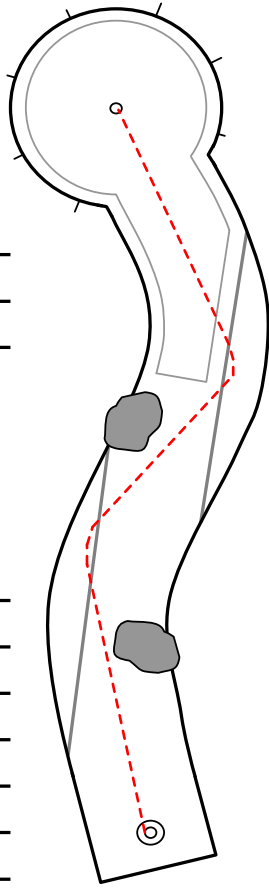

# 6 moat

ball: Ravensburg 141, 250, 251

spot:

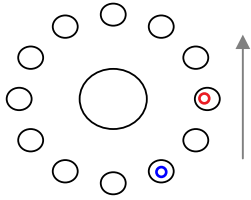

note: \_\_\_\_\_

---

---

---

---

---

---

---

---

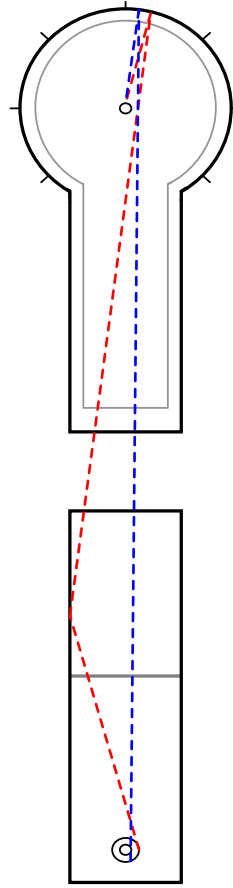

# 11 wall

ball: SV 28

spot:

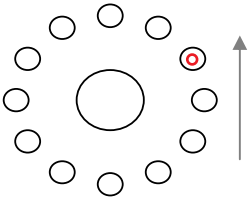

note: \_\_\_\_\_

---

---

---

---

---

---

---

---

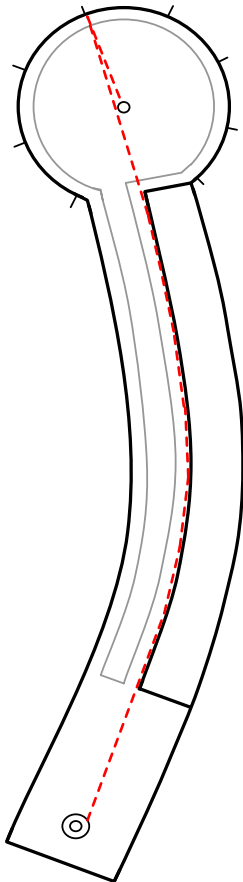

# 8 volcano

ball: BoF Peter/Sandra Nordin

spot:

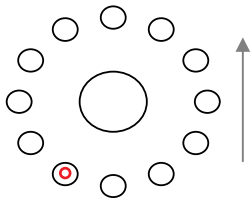

note: \_\_\_\_\_

---

---

---

---

---

---

---

---

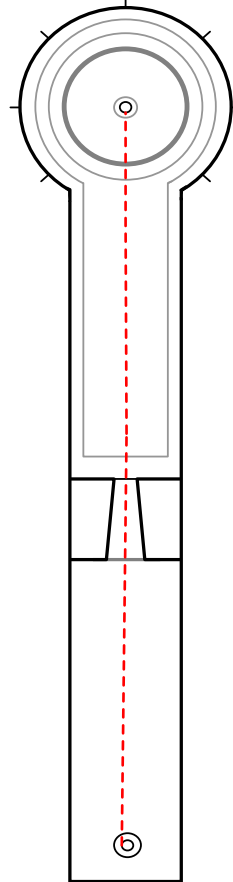

# 7

hammer cage

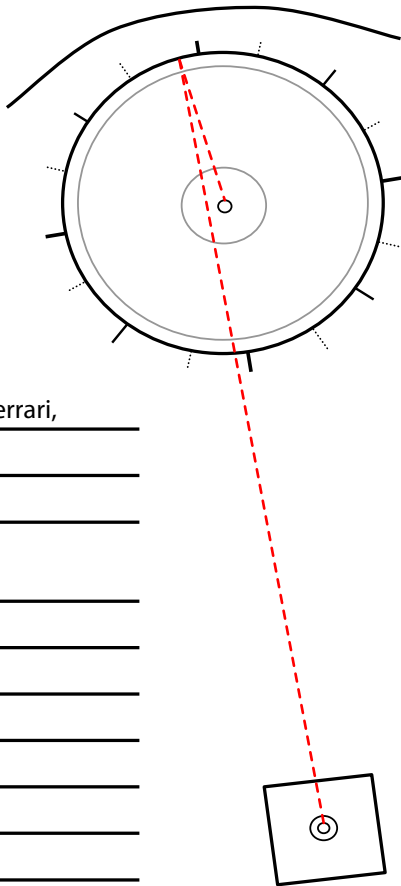

ball: Reisinger Ferrari,  
Ravensburg 250

note: \_\_\_\_\_  
 \_\_\_\_\_  
 \_\_\_\_\_  
 \_\_\_\_\_  
 \_\_\_\_\_  
 \_\_\_\_\_

# 12

wide angle

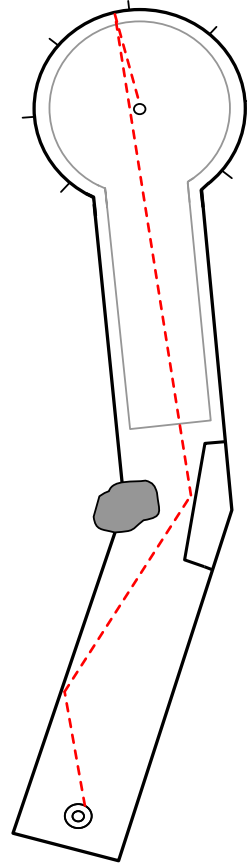

ball: Reisinger Grünes Band,  
Reisinger 20J. Osnabrück "Rot",  
Reisinger BO 2

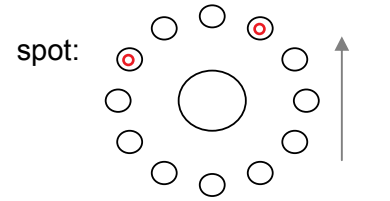

note: \_\_\_\_\_  
 \_\_\_\_\_  
 \_\_\_\_\_  
 \_\_\_\_\_  
 \_\_\_\_\_  
 \_\_\_\_\_

ball: NIFO 2  
 \_\_\_\_\_  
 \_\_\_\_\_

# 9

open corner

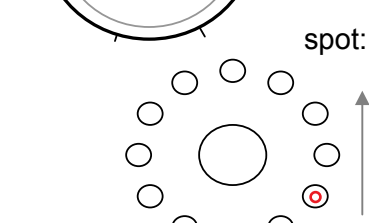
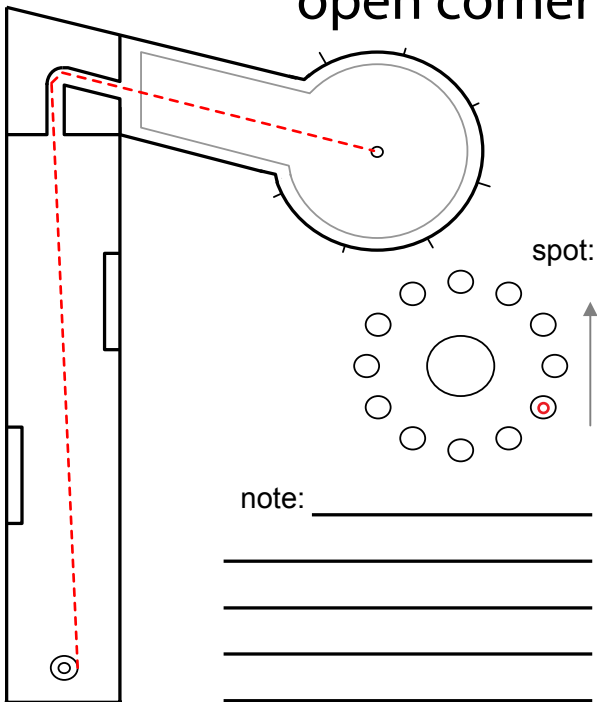

note: \_\_\_\_\_  
 \_\_\_\_\_  
 \_\_\_\_\_  
 \_\_\_\_\_  
 \_\_\_\_\_

# 10

triple hill

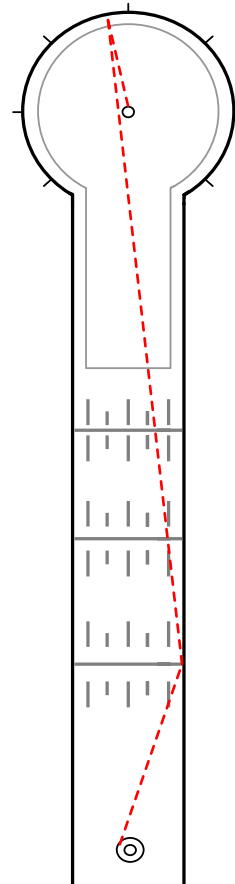

ball: M&G Weichei,  
M&G Gebi 17

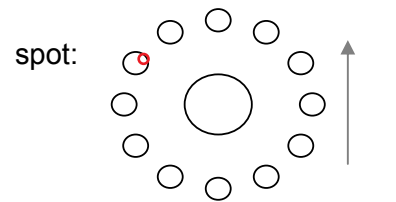

note: \_\_\_\_\_  
 \_\_\_\_\_  
 \_\_\_\_\_  
 \_\_\_\_\_  
 \_\_\_\_\_  
 \_\_\_\_\_