

17

open tunnel

ball: Reisinger Piepen 1.0,
BoF Sandra Weaver ML

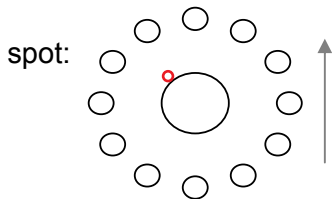

note: Ballen må ikke gå
nærmere koppen en ca 5 cm på
venstre side, for da vil ballen
gå venstre side tilbake. Det fins
et tilbakerull mellom koppen
og klokken 4, og derfor er det
viktig med riktig tempo.

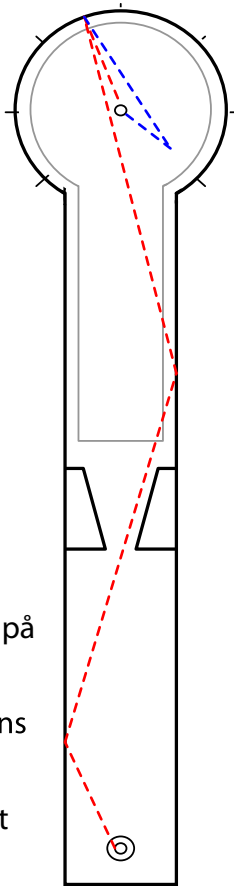

2

Stonehenge

ball: 3D 613 MR
Noen spiller en nedspilt
3D 613 MR, som bremser mer
før green.

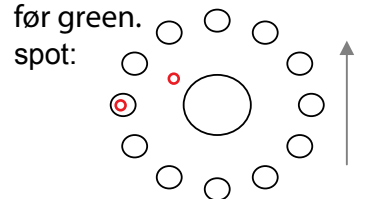

note: Banen drar venstre og
det er viktig med riktig treff i
vantet og rett tempo for at
ballen skal følge dragingen i
banen. Ved løse slag drar ballen
en del høyre fra ca 1 meter før
venstre stein og til koppen.
Ballen skal gå direkt.

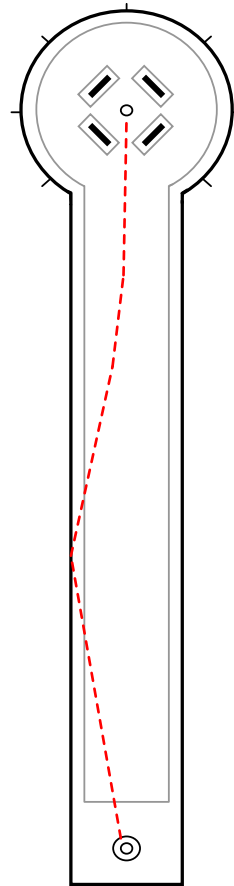

15

terrace

ball: 3D 413,
3D Gullbergsbro 60 år
Ballene må varmes litt.

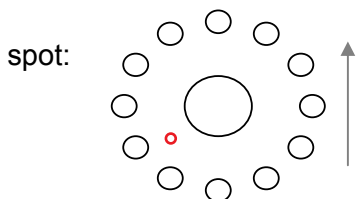

note: ca 20 cm og myk.
Spill ballen inn litt høyre i
oppgangen, og litt bestemt.
Ballen må gå nære koppen på
venstre side.

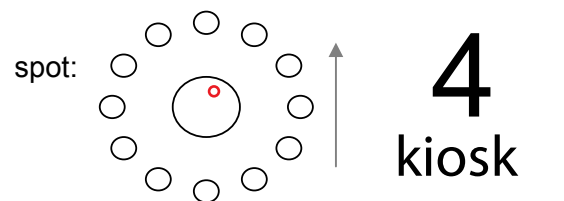
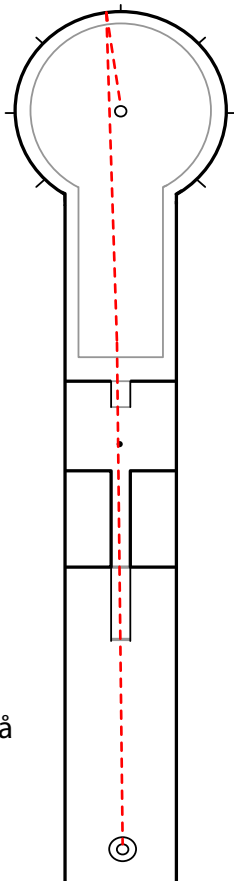

4

kiosk

ball: 3D 513 KR,
M&G Rabbit KR, BoF Fritz Voss KR
BoF EC2008 Uppsala KR

note: ca 30 cm og matt.
Banen drar venstre. Ballen skal
gå ca 5 cm venstre om koppen.

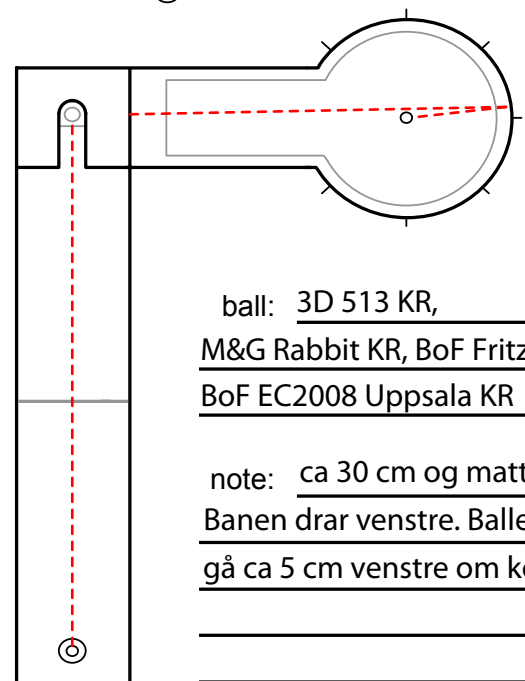

3 oyster

ball: SV MEJ Olomouc 1992
Ballen må være veldig varm.

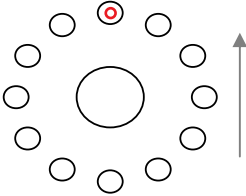
spot: 

note: _____

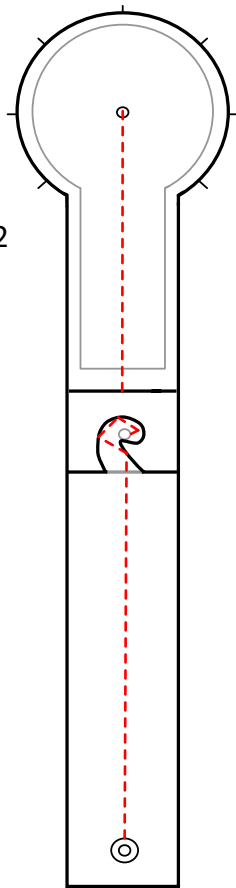

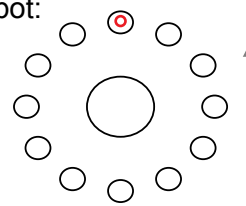
spot: 

16 tube corner

ball: Klikker (gjennomsiktig)

note: _____

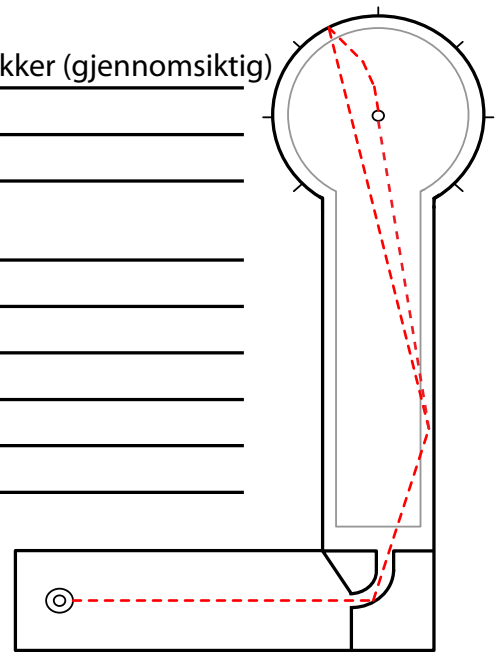

5 velodrome

ball: 3D 836 MX, 3D 826 KL,
BoF Paolo Porta KX,
Ravensburg 085 MX

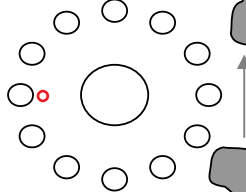
spot: 

note: _____

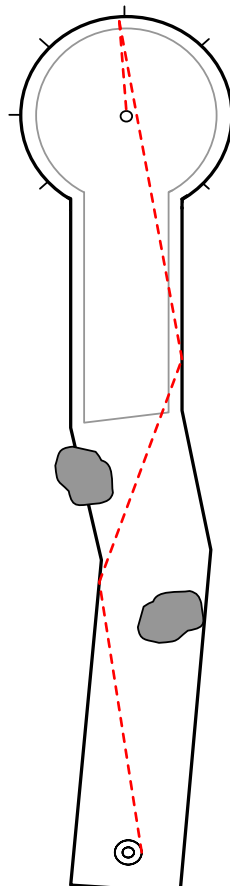
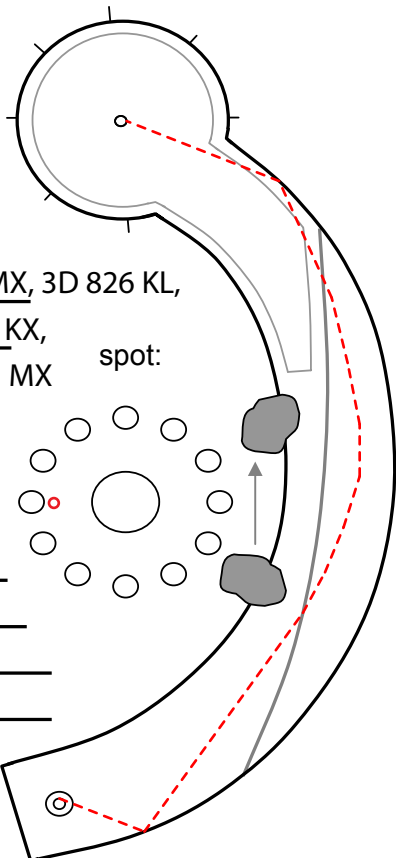

14 stones

ball: DM 087 (Baumer)
3D SEM Cheb,
BoF Sandra Weaver ML / MX

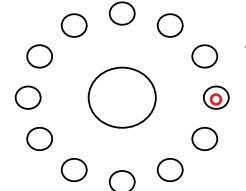
spot: 

note: Spill to-vant-slag. Første
treff skal være ca 20 cm før
enden på vantet. Ballen skal gå
ca 5-10 cm høyre om koppen.

13 double velo

ball: Mg Turbo 2r (Varm),
BoF Martin Sjøberg KL
 Noen spiller også M&G Rabbit KR
 eller lignende.

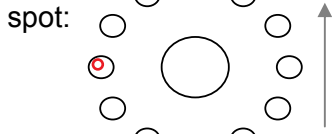

note: Legg ballen helt ut
venstre, og spill løst nære (10 cm)
steinen. Ballen skal gå ca 10 cm
høyre om koppen og skal ha
2 vanttreff.
Banen drar mye høyre ved
putting langt utenfor green.

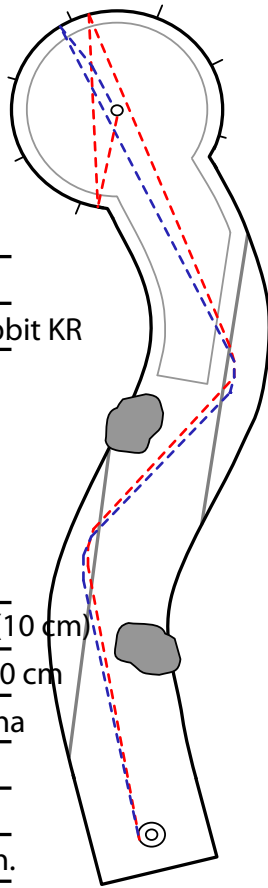

6 moat

ball: Ravensburg 251
Varmes litt.

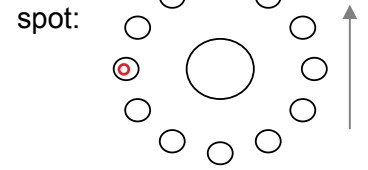

note: _____
Vanttreff ca 20 cm før midten.

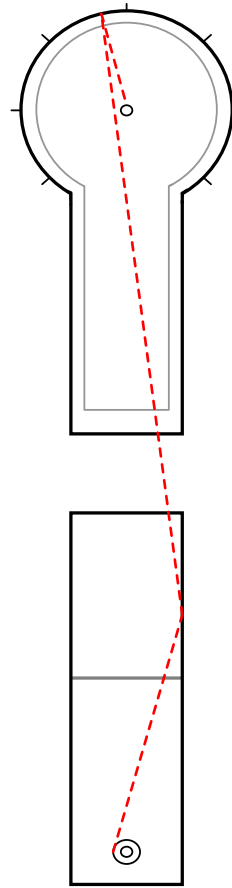

11 wall

ball: Klikker
 Noen spiller også død ball.

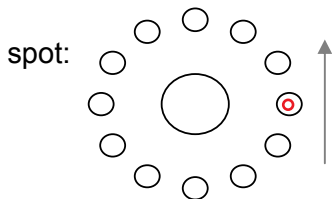

note: _____

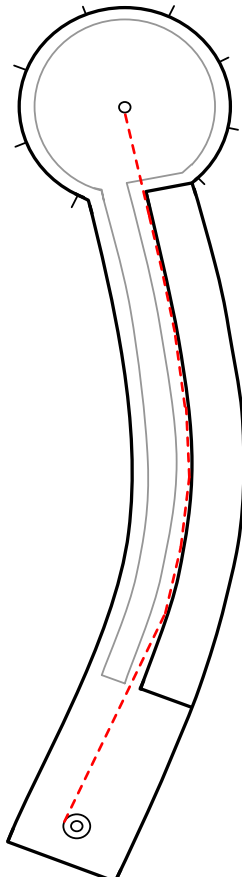

8 volcano

ball: BoF Mainz 2007
 Noen spiller litt raskere ball,
 men myk.

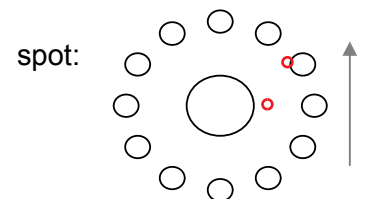

note: Død og myk ball. Banen
drar høyre. Legg ballen høyre
og spill venstre.

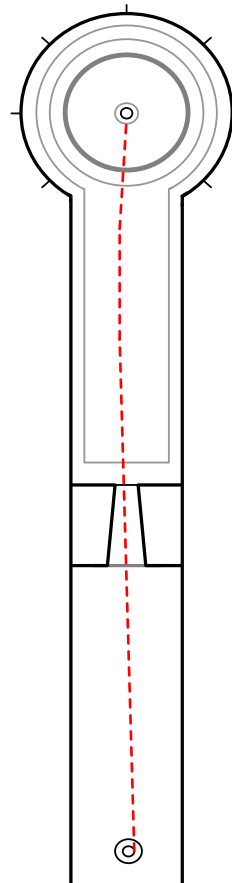

7

hammer cage

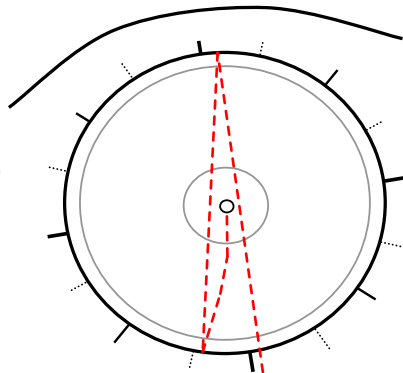

ball: DM Super 10, Nissan Trofeo 2011 MR,
Mange spiller baller som er ca 70 cm,
og litt mykere enn Super 10.

note: Ballen skal gå ca 5-10 cm
høyre om koppen for å få rett
gang på green.

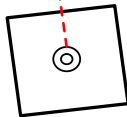

12

wide angle

ball: BoF Jonas Gustavsson,
BoF Antonio Goiorani

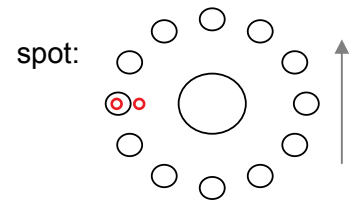
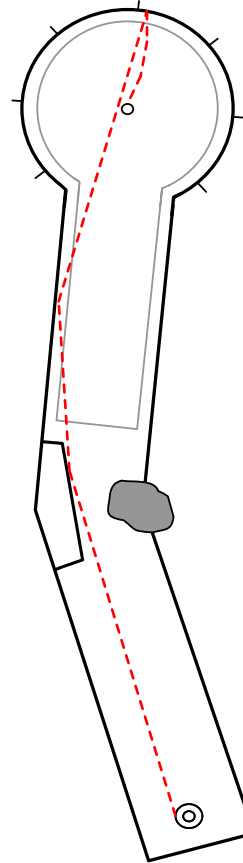

note: Legg ballen helt ut
venstre og spill direkte på
hinderet. Treffene på hinderet
må være etter midten slik at
vantreffene etter hinderet ikke
blir for langt ned. Ballen skal gå
5-10 cm venstre om koppen.

ball: Reisinger klikker (tung)

9

open corner

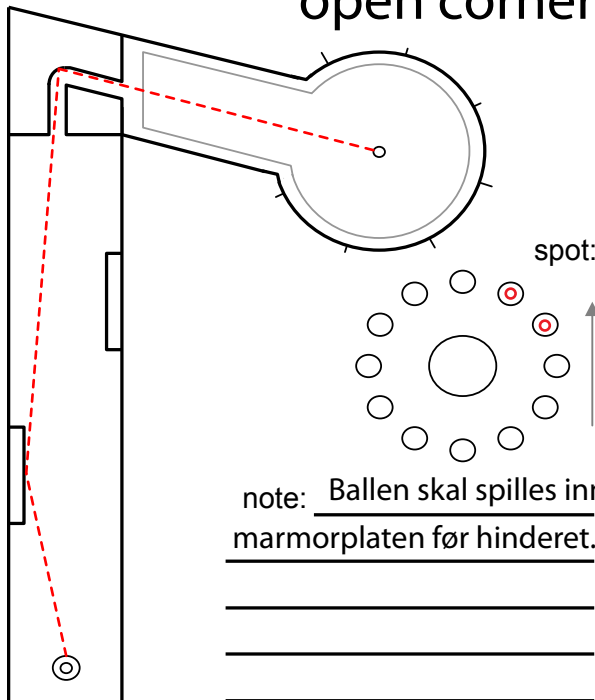

spot:

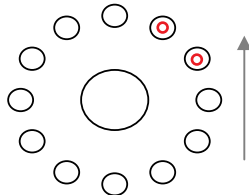

note: Ballen skal spilles inn i
marmorplaten før hinderet.

10

triple hill

ball: Nissan Trofeo 2009,
Sportpark dieci

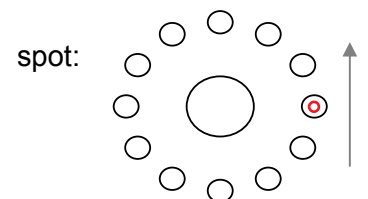
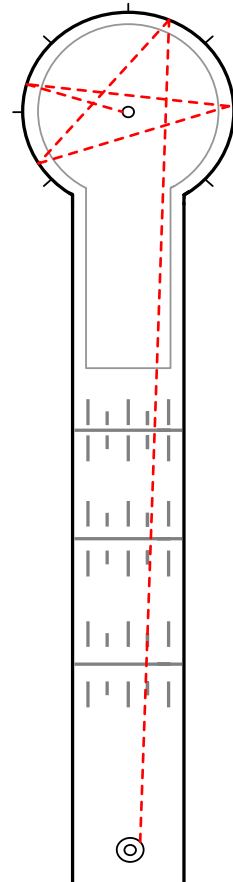

note: Legg ballen lengst ut
høyre og spill rett over kulene.
Ballen skal gå ca 5-10 cm
venstre for utflytningslinjen for
å få rett gang på green. Ballen
skal ha vantreff ca 5 cm høyre
for klipset på green.
